

LED矩阵式光引擎模组规格书

SPECIFICATION

产品型号 Module. P/N NO.: MATBEAM1000-V1

送承日期 Documents. NO.:

深圳市同一方光电			客户/Customer (加盖公章) 公司名称:		
制作 Maker	审核 Checked	批准 Approved	工程 Engineering	品质部 Quality	批准 Approved

目录

1、产品信息 Product Information	3
2、光电特性 Electrical-Optical Characteristics	4
3、光色参考图 The reference map color area	6
4、典型特性曲线 Typical Characteristic Curves	7
5、输出光型 Optical output character	9
6、极限参数 Absolute Maximum Ratings	10
7、热学参数规格 Thermal Specification	10
8、电气性能结构 Electrical Specification	12
9、结构尺寸规格 Mechanical Specification	13
10、产品包装 Product Packaging	15
11、使用说明 Instructions for Use	16
12、注意事项使用说明 Precautions	17

1、产品信息 Product Information

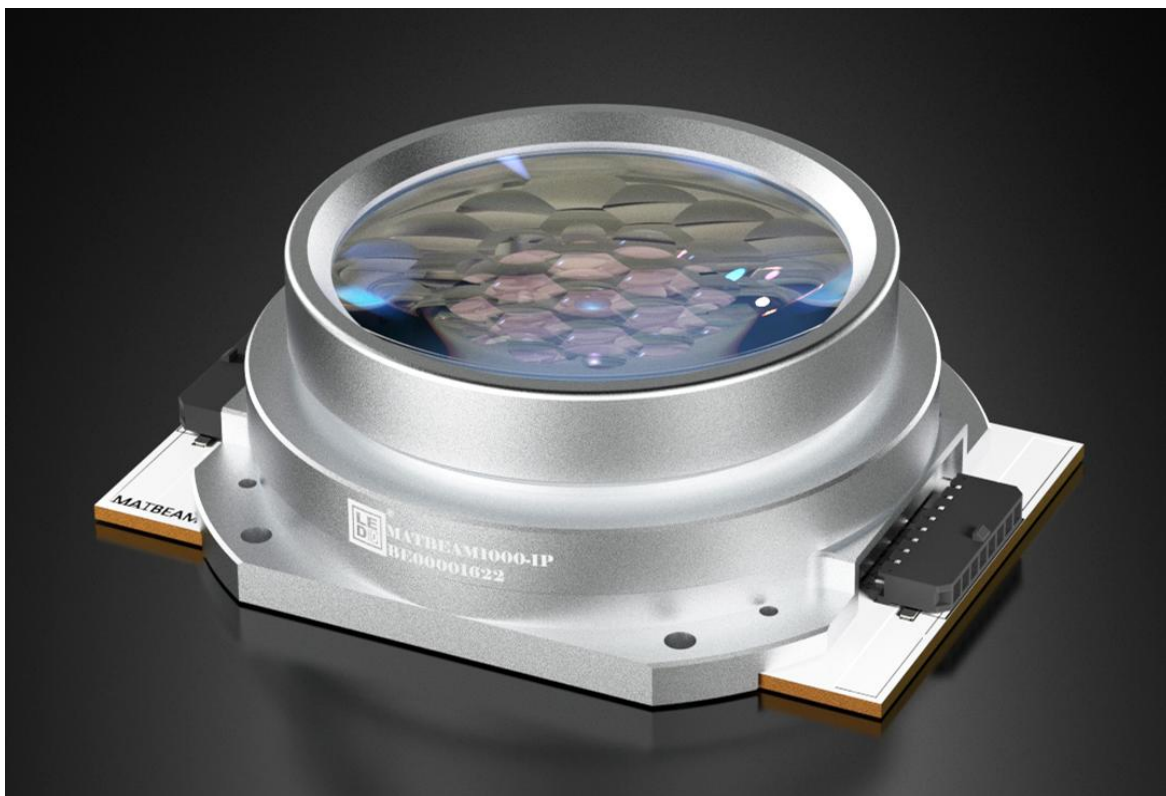

基于MATBEAM1000的LED模组

MATBEAM1000 系列是一款矩阵式 LED 模组的聚光镜头，该镜头采用了具有专利的创新式聚光设计，具有高密度均匀聚光的特点，应用时可在焦点放置与焦点同样大小的光阑或者图案片。与之匹配的 LED 矩阵使用 37 颗芯片。MATBEAM1000 光学镜头与 LED 矩阵通过简单的安装即可组装成大功率的 LED 模组，具有效率高、光密度高，易于升级与维护等特点，是各种专业照明器具的理想光源方案，如户外探照灯、远程投光灯、追光灯、摇头图案灯、摇头三合一灯等；

1.1、MATBEAM1000-IP-PCBA聚光镜头：

适配LED:可适配37颗5050封装芯片

出光口径：φ78mm

效率：大于80%

光阑：φ16.8mm

出光角度：56°

外形尺寸：L 94 mm x W 92 mm x H 36.1mm

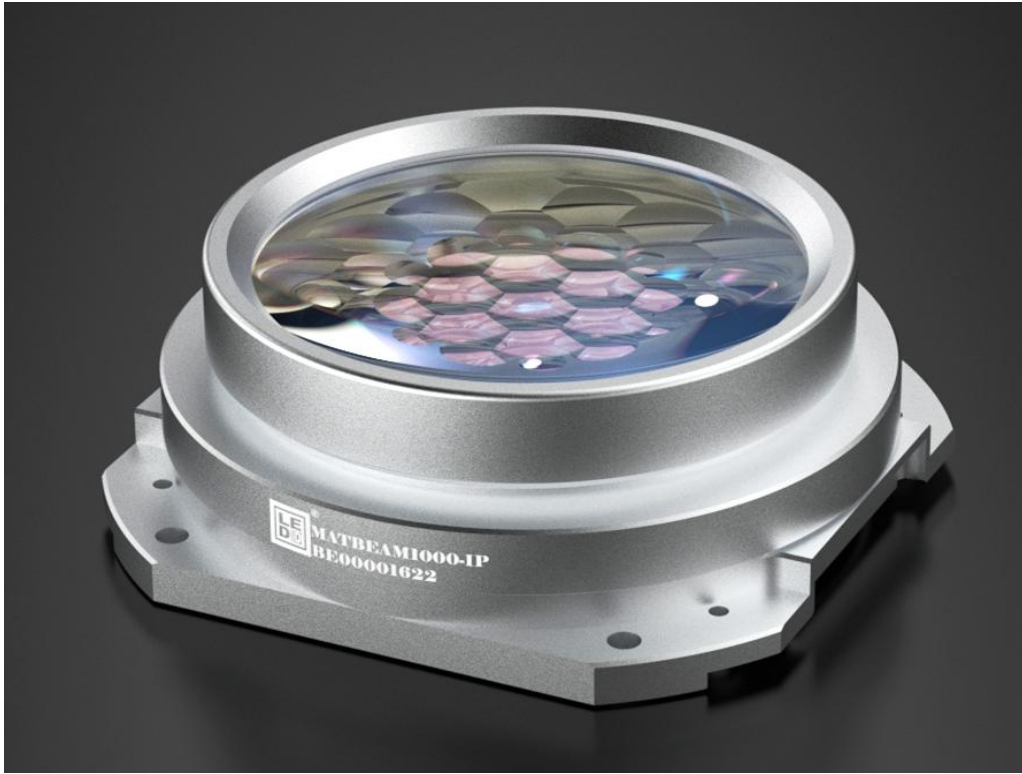

MATBEAM1000聚光镜头外观

1.2、矩阵式LDE光引擎光源板：

LED 芯片：采用高亮高光密度芯片

功率：360-1000W

输入电流：3路独立恒流输入，6A/路

光通量：搭配采用Toplite复眼模组光学镜头的LED模组测试达到45000lm

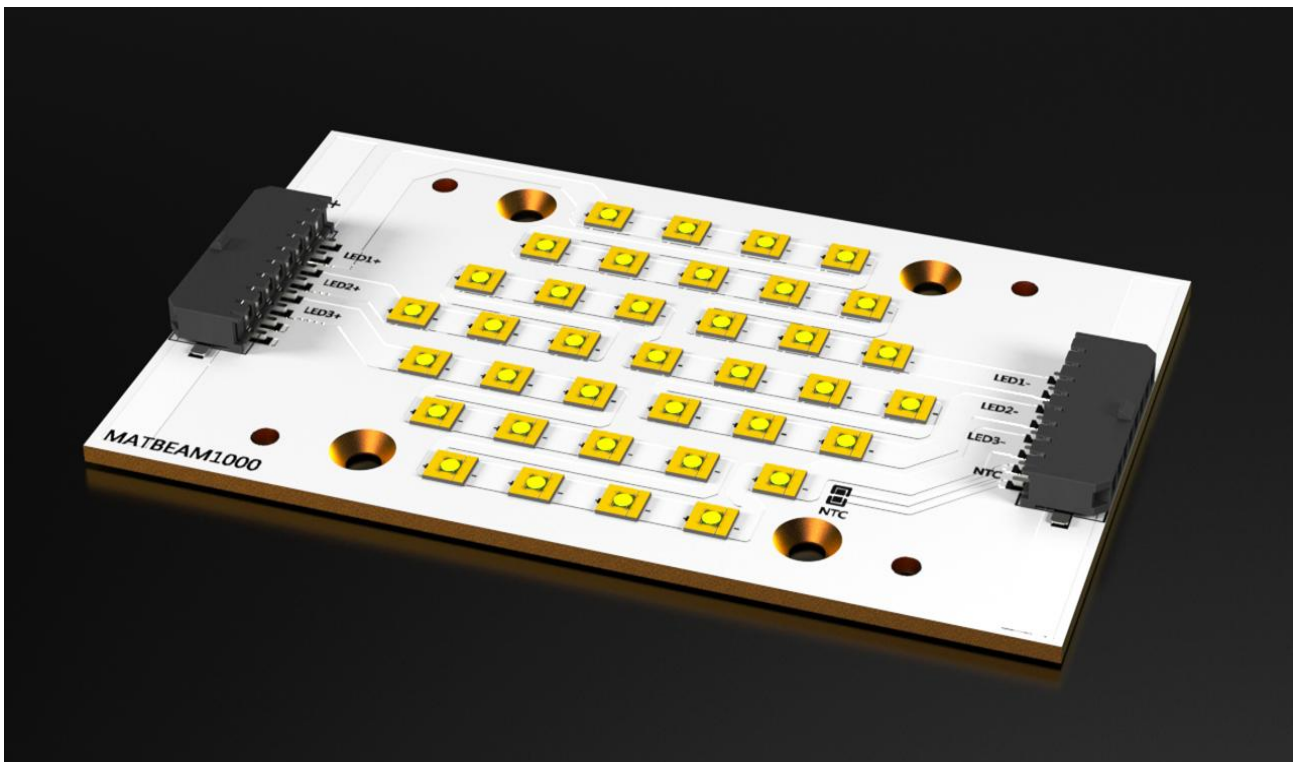

LED矩阵式光引擎光源板

2、光电特性 Electrical-Optical Characteristics

产品型号	If电流 (A)	项目 Item	符号 Symbol		参数 Parameter	单位 Unit
MATBEAM1000-V1	3-7A	色温 CCT	Typ	CCT	8000	K
			Max		9000	
			Min		7000	
		光通量 Pulsed Flus	TYP	Φ_v	45000	lm
			Max		52000	
			Min		26000	
		显指 CRI	TYP	Ra	95.4	/
			Max		96.2	
			Min		95	
		色区坐标 Chromaticity Coordinates	Typ	X	0.3036	/
			Typ	Y	0.3024	

注1: 所有规格均为初步规格, 可能会有更改。所有参数都基于恒定散热器的运行。

Note 1: All specifications are preliminary and are subject to change. All parameters are based on operation with a constant heat sink.

注2: 工作温度为热敏电阻的计算温度。给定的最大值和推荐的工作热敏电阻温度是在不使用CMY系统的条件下。如果使用CMY系统, 则应适当调整该值。

Note 2: The operating temperature refers to calculated temperature of thermistor. The given value of the maximum and recommended operating thermistor temperature is in the condition of no using CMY system. If CMY system is used, the value should be adjusted appropriately.

注3: 输入电源和热系统必须妥善管理, 以确保使用寿命。

Note 3: Input power and thermal system must be properly managed to ensure life time.

3、光色参考图 The reference map color area

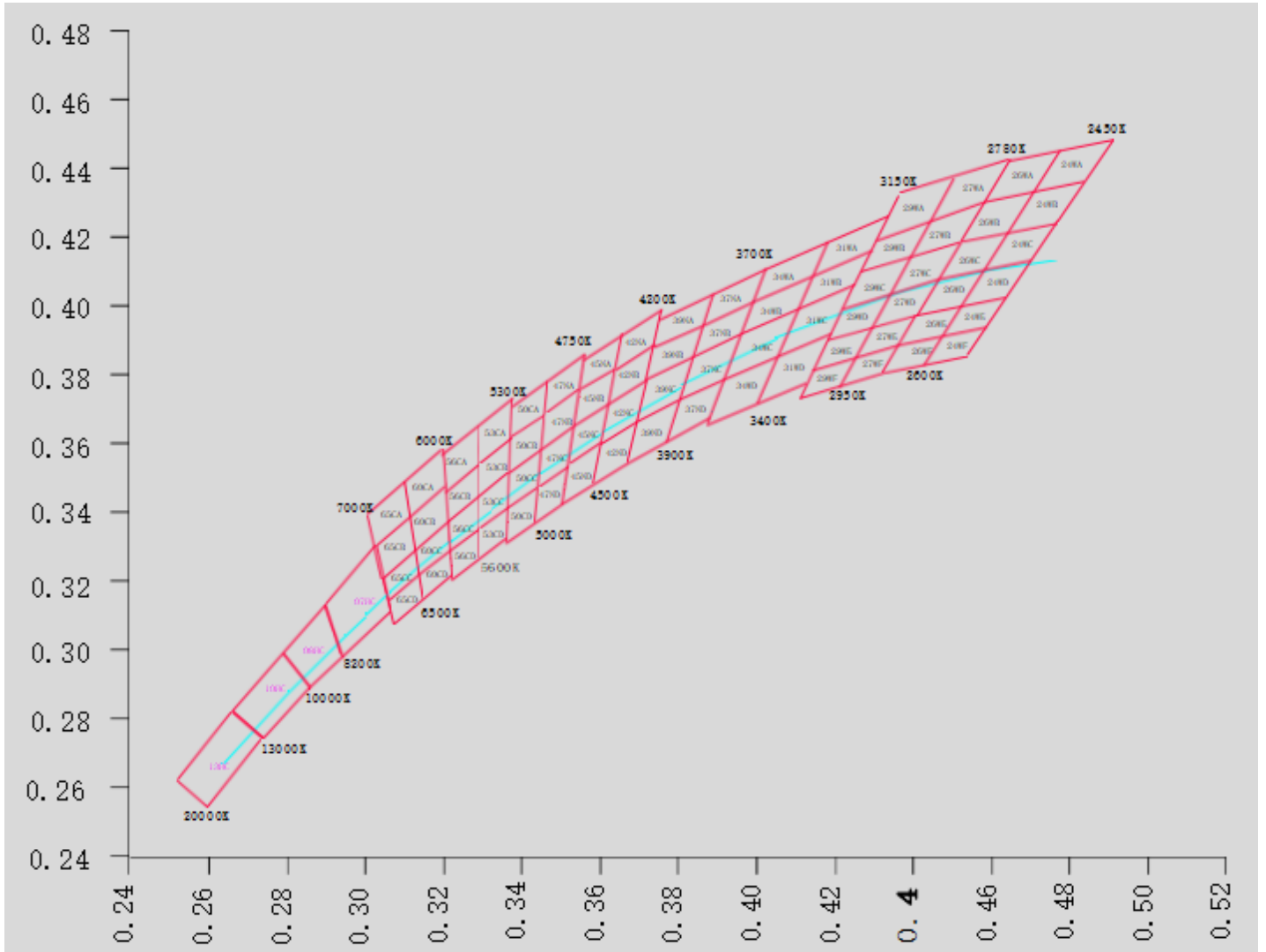

4、典型特性曲线 Typical Characteristic Curves

4.1、典型光谱分布 Typical spectrum

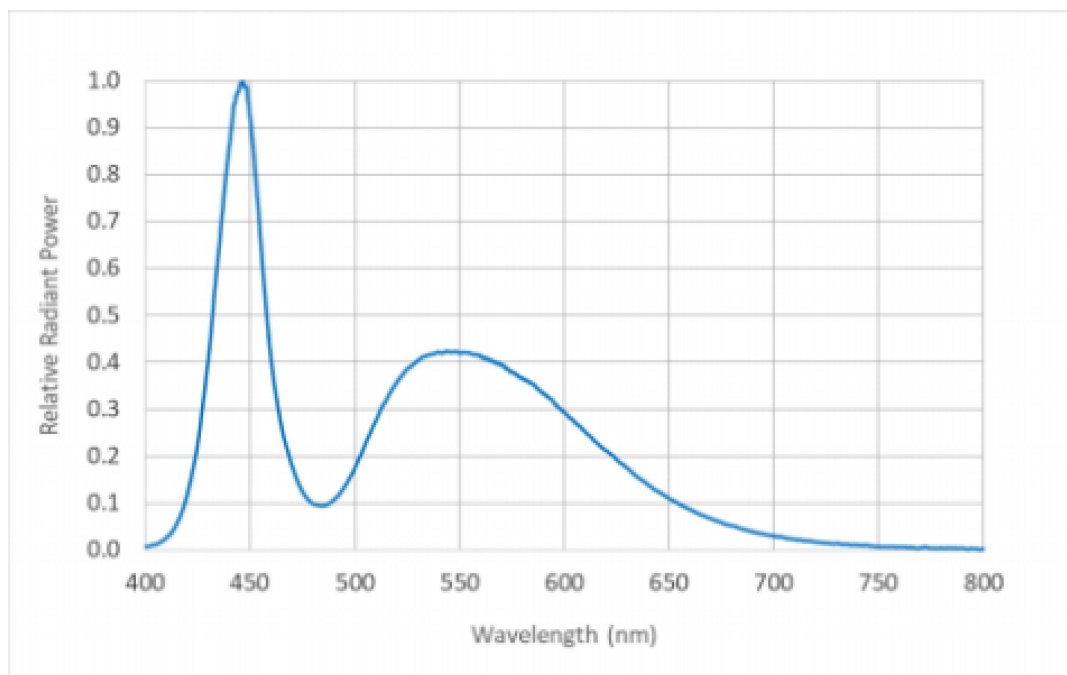

4.2、典型发光角度辐射图 Typical Light-Emitting Angle Radiation Pattern

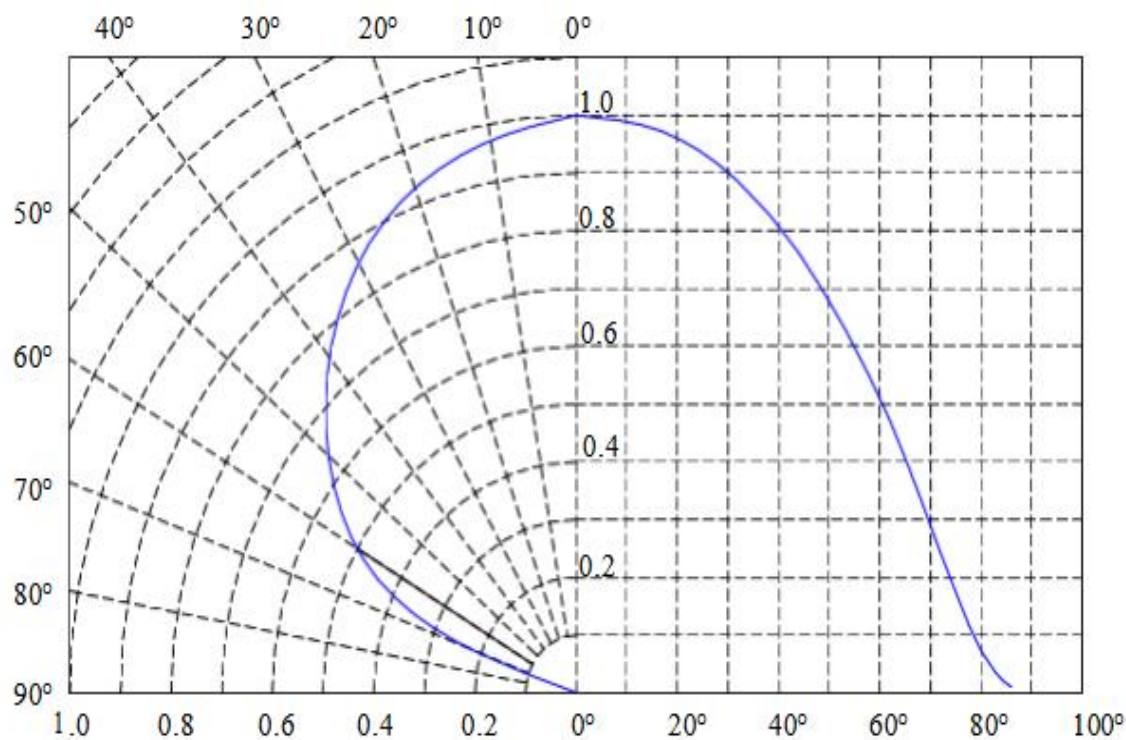

4.3、输出光通量与温度相对曲线 Relative Output Flux vs.Board (Thermistor:Tref) Temperature, IF=6.0A

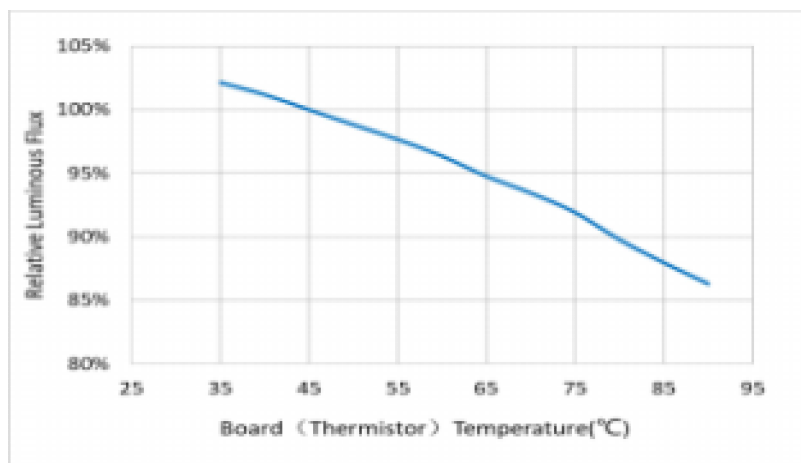

4.4、色温与温度相对曲线 Correlative Color Temperature vs.Board (Thermistor:Tref) Temperature, IF=6.0A

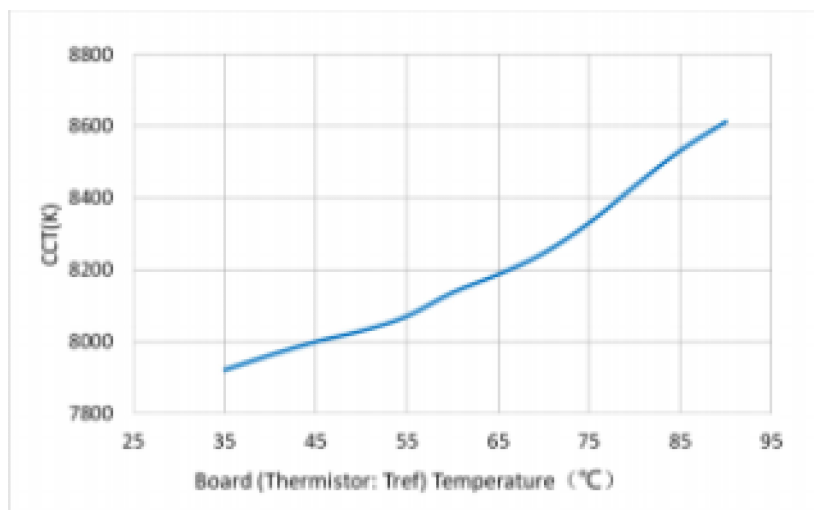

4.5、输出光通量与电流相对曲线 Relative Output Flux vs. Forward Current

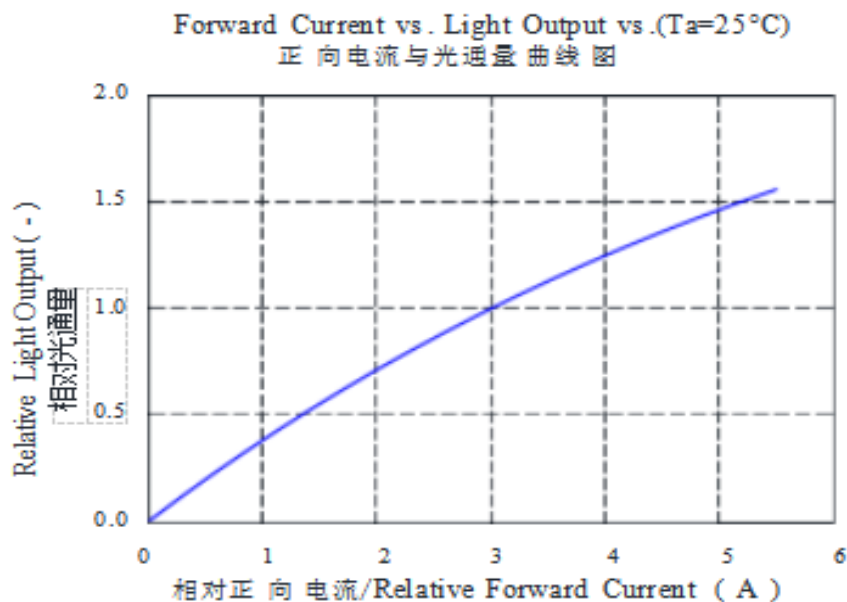

5、输出光型 Optical output character

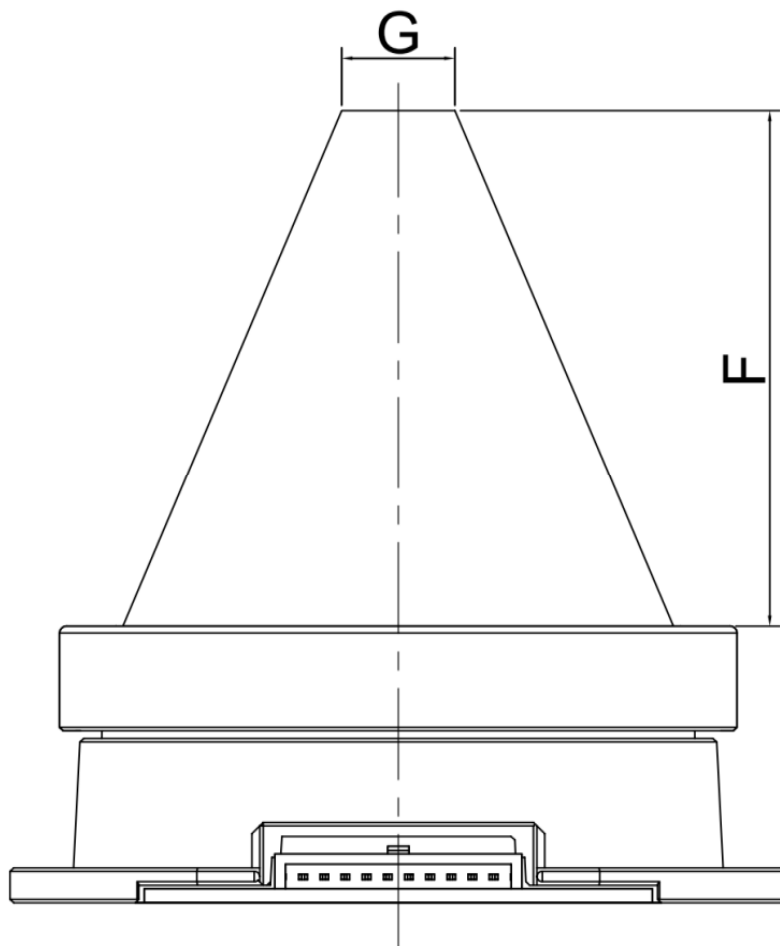

输出光型图

注4: G: 16.8MM ,F:56±2MM, 出光角度56°

F是光源输出透镜的焦距。如果点距之间的距离变化, 可能会引起光斑均匀性的变化。

F is the focus length of light source output Lens. It may cause variation of uniformity of spot if the distance between output lens and gobo is out of the tolerance of F.

此光形是基于LED为TYF-5050-30W或具有与之相同的发光面大小的LED。

This light shape is based on led with TYF-5050-30W or the same luminous surface size.

6、极限参数 Absolute Maximum Ratings

项目 Item	符号 Symbol	参数 Parameter	单位 Unit
最小电流 Minimum Current	Min IFMIN	50	ma
最大电流 Maximum Current	Max IFMAX	6.0	A
浪涌电流 Surge current($t \leq 10\mu\text{s}$; $D=0.005$; $T_s = 25^\circ\text{C}$)	Max IFM	6.0	A
最高工作热敏电阻温度 Maximum Operating Thermistor Temperature	Max	80	$^\circ\text{C}$
储存温度范围 Storage Temperature Range		-40/85	$^\circ\text{C}$

注5：在绝对最大值下持续操作将缩短寿命。

Note 5 : Sustained operation at Absolute Maximum Ratings will result in a reduction of life time.

注6：工作温度为热敏电阻的计算温度。给定的最大值和推荐的工作热敏电阻温度是在不使用CMY系统的条件下。如果使用CMY系统，则应适当调整该值。

Note 6 : The operating temperature refers to calculated temperature of thermistor. The given value of the maximum and recommended operating thermistor temperature is in the condition of no using CMY system. If CMY system is used, the value should be adjusted appropriately.

7、热学参数规格 Thermal Specification

7.1、LED封装结构图 LED package structure diagram

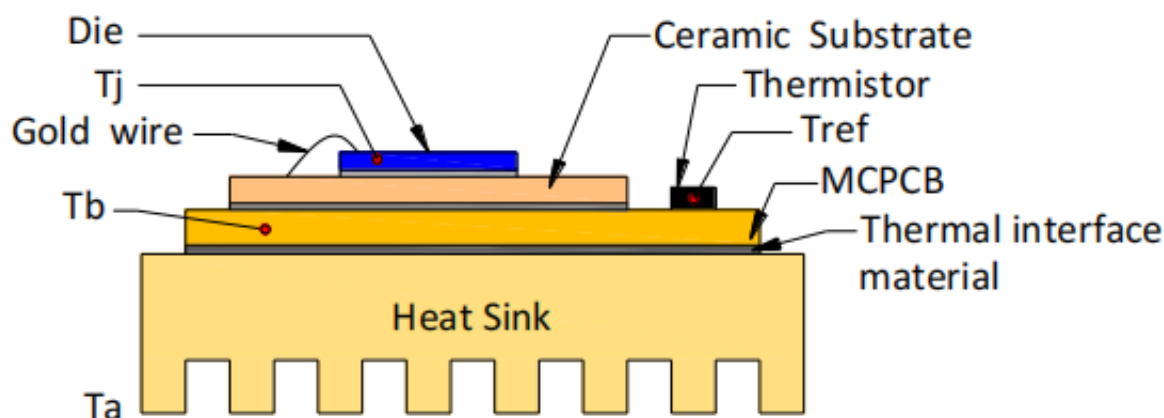

7.2、LED光源板（热敏电阻）温度与热敏电阻关系曲线 LED light source plate (thermistor) temperature and thermistor relationship curve

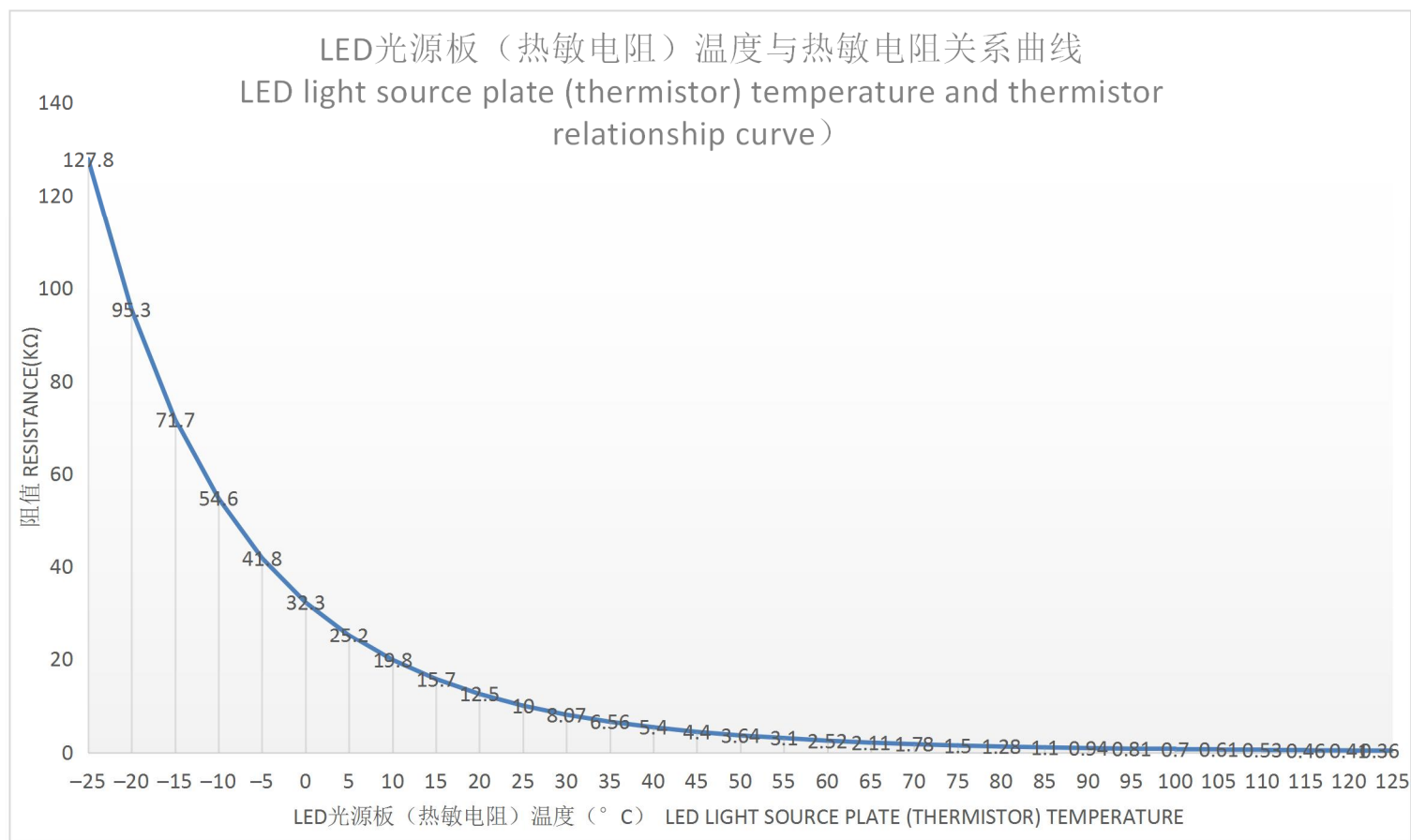

8、电气性能结构 Electrical Specification

8.1、通道引脚分配 Channel Pin-Assignment

P1	P2	P3	P4	P5	P6	P7	P8
LED1+	LED1+	LED2+	LED2+	LED3+	LED3+	/	/
P9	P10	P11	P12	P13	P14	P15	P16
LED1-	LED1-	LED2-	LED2-	LED3-	LED3-	NTC	NTC



通道引脚分配图示

8.2、分路接线组合示意 Schematic diagram of shunt connection

产品型号	灯珠数量	串并	分路	功率(W)	电流(A)	电压(V)
MATBEAM1000-V1	37	12S1P	1路(LED1)	270	6A	45
		13S1P	2路(LED2)	300	6A	48
		12S1P	3路(LED3)	270	6A	45
		1S1P	NTC	/	/	/

9、结构尺寸规格 Mechanical Specification

9.1、结构尺寸 Mechanical Dimensions

项目 Item	长度 Length	宽度 Width	高度 Height	单位 Unit
矩阵式LDE光引擎光源板	116	72	3	mm
Toplite复眼模组光学镜头	94	92	36.1	mm

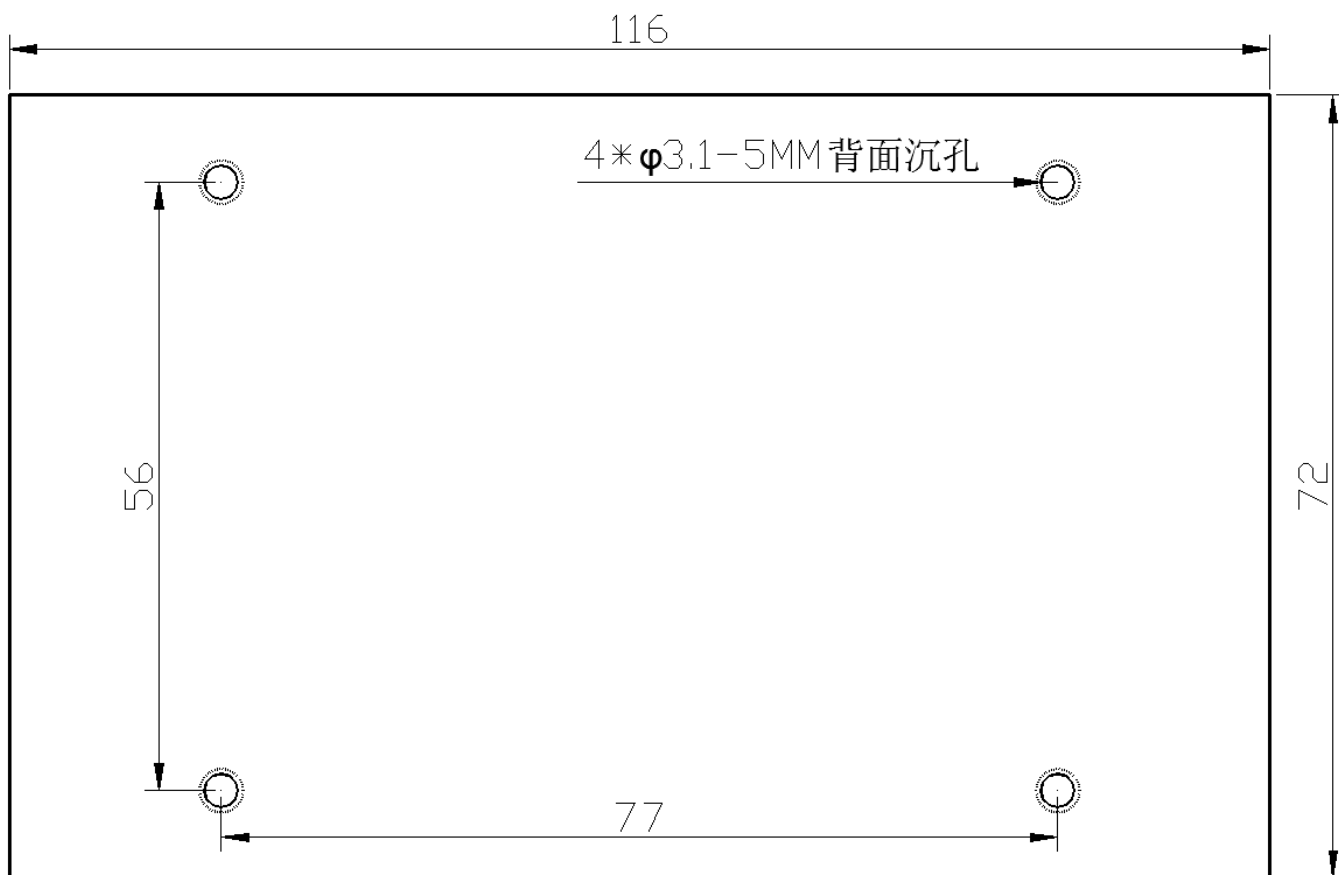

矩阵式LDE光引擎光源板结构尺寸

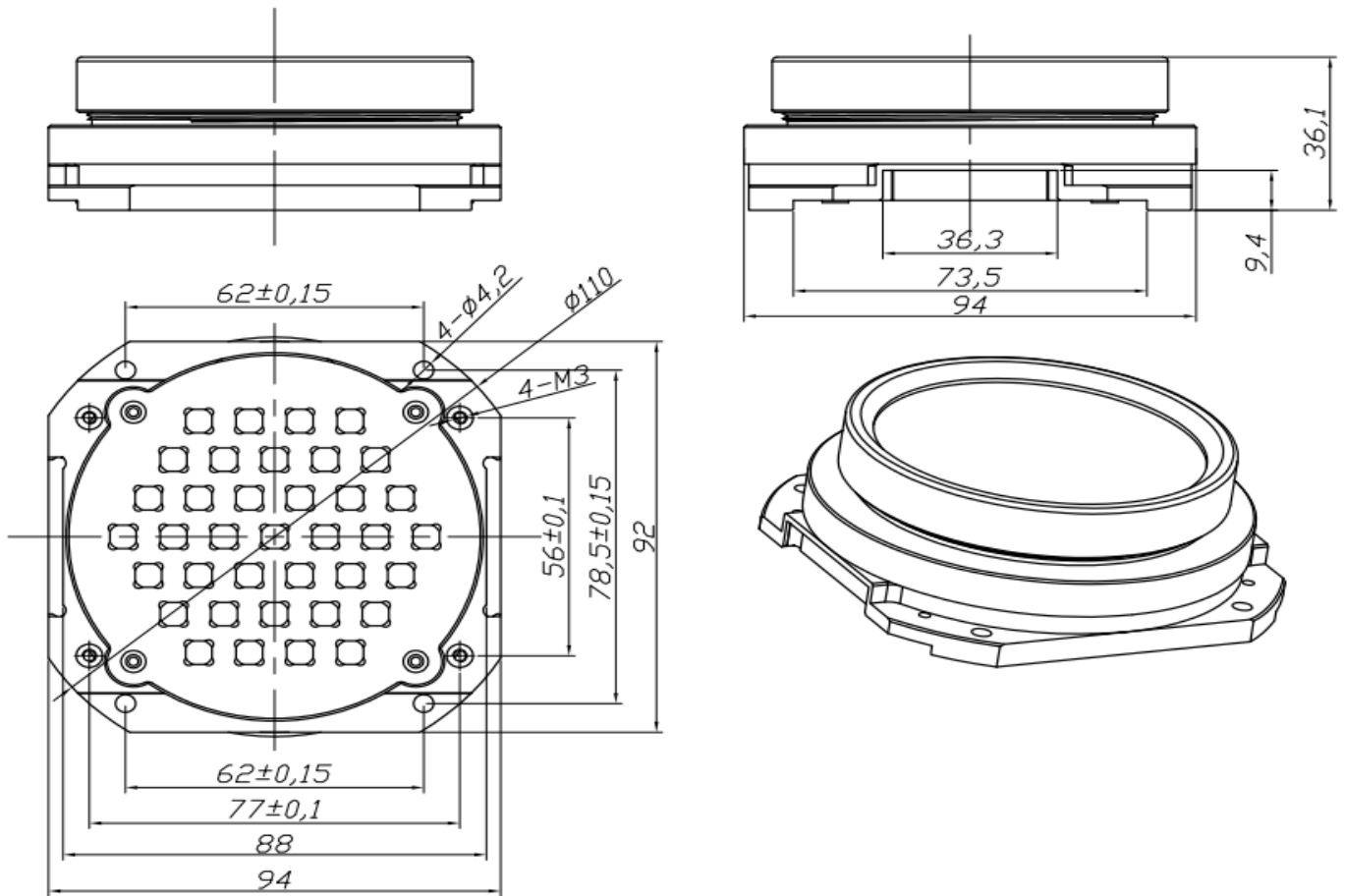

Toplite复眼模组光学镜头结构尺寸

9.2、散热器孔位示意图 Schematic diagram of radiator holes

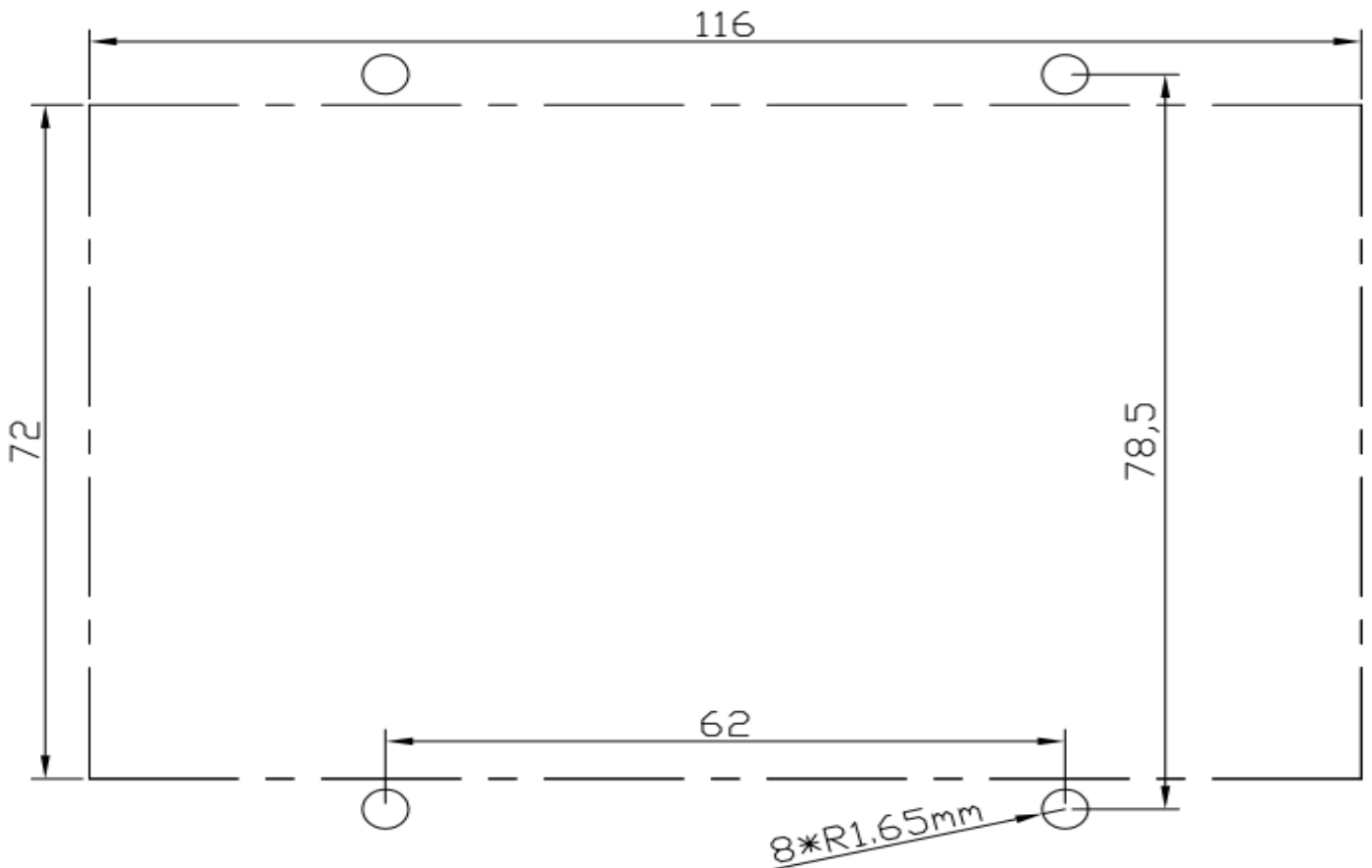

10、产品包装 Product Packaging

对LED模组产品包装，采用防静电吸塑托盘和防静电气泡袋两种包装。通常情况LED模组采用防静电吸塑托盘。每个托盘（气泡袋）XX片如下图所示。包装好的成品密封好后放入卡通箱如下图所示。

The LED module products are packaged in two types antistatic blister trays and antistatic bubble bags. Normally, LED modules use anti-static blister trays. Each tray (bubble bag) carries XX pieces of modules, as shown below. The packaged finished products are put into in cartons after sealing, as shown below.

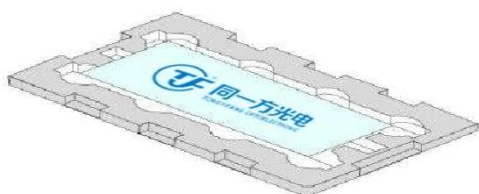

1. 每个托盘xx片LED模组

1. Each tray carries xx pieces of LED modules.

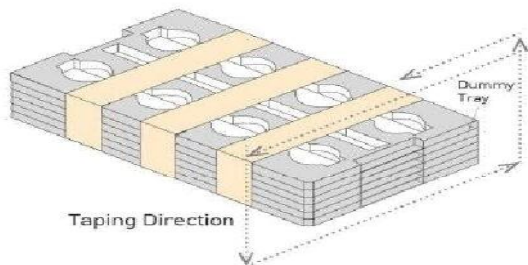

2. 托盘堆叠与胶带，每箱由XX托盘加上一个空托盘组成，每个托盘加一小包干燥剂。

3. Tray stacking and taping: Each carton holds xx module trays and one empty tray.

A packet of desiccant is put onto each tray.

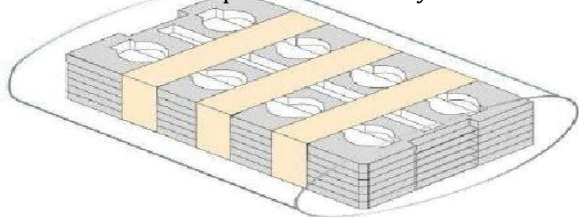

3. 包装箱信息与包装

3. Packing-case information and packaging

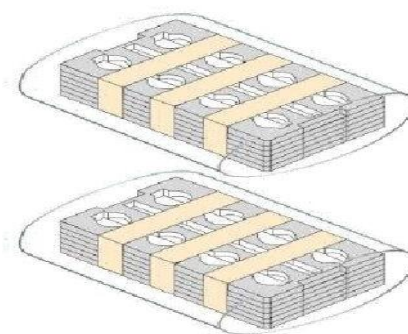

4. 绝缘密封包裹，尺寸：XXXmm x XXXmm)

每箱一共XXX片模组，重量XXX KG

4. Insulated and sealed package, size: XXXmm x XXXmm)

A total of XXX modules per carton, weight XXX KG

11、使用说明 Instructions for Use

11.1、 本产品需驱动电源，在使用、测试时需配备散热器，并确保灯板Tc点温度不超过 85℃。

11.1、 This product require a driving power supply. It is necessary to provide a heat radiator for its use and testing. Also, it shall be ensured that the temperature at the Tc point of the lamp panel does not exceed 85 °C.

11.2、 本产品可用螺丝固定在散热器的安装面上，散热器安装表面需平整光滑，表面并均匀涂覆导热膏，确保光源板底部与安装平面完全接触。（请勿采用劣质导热硅脂或其他黏结物质如万能胶水等，不但起不到导热作用，反而形成隔热层。散热不良使用会降低本产品使用寿命，严重时会造成死灯）

11.2、 This product can be fixed on the mounting surface of the heat radiator with screws. The mounting surface of the heat radiator must be flat and smooth and evenly coated with thermal conductive paste, to ensure that the bottom of the light source board is completely in contact with the mounting plane. (Do not use inferior thermally conductive silicone grease or other bonding materials like all-purpose adhesive, which can not provide heat conduction, but form a thermal insulation layer. Poor heat dissipation will reduce the service life of the product and may cause LED damage in severe cases).

11.3、 在焊接输入导线时，请严格按灯板上标识焊接正极和负极，请勿反接。

11.3、 When welding the mains supply input lead, please strictly follow the identification on the lamp panel to weld Anode line and cathode line, and do not make reverse connection.

11.4、 防硫化、氯化、溴化等处理：在密闭、高温的环境中，灯具内可能含硫/氯/溴等物质，这些硫、氯和溴元素会挥发成气体并腐蚀 LED 光源。因为 LED 封密硅胶具有多孔性结构，与光源镀银层发生硫化反应。LED 光源出现硫化反应后，产品功能区会黑化，光通量会逐渐下降直至微亮，色温出现明显漂移，LED 光源最终会失效。建议您进行灯具排硫测试，确保 LED 光源在无硫/氯/溴等物质环境进行工作。

11.4、 Treatments like sulfurization, chlorination and bromination prevention: In a closed, high-temperature environment, the lamp may contain sulfur/chlorine/bromine and other substances. These sulfur, chlorine and bromine elements will volatilize into gas and corrode the LED light source. Because the LED sealed silica gel has a porous structure, it reacts with the silver plating layer of the light source. After the sulfurization reaction of the LED light source occurs, the functional area of the product will be blackened, the luminous flux will gradually decrease until it is slightly bright, the color temperature will obviously drift, and the LED light source will eventually fail. It is recommended that you perform a sulfur emission test on the lamp to ensure that the LED light source works in a sulfur/chlorine/bromine-free environment.

12、注意事项使用说明 Precautions

在下列情况使用本产品，本公司不承担任何损失和责任

The company will not bear any loss and responsibility for using this product in the following conditions.

12.1、在通电情况下，不能直接用手触摸本产品任意零件的焊盘裸露区，建议带电测试本产品时，测试员需配戴绝缘手套。

12.1、When the power is on, do not directly touch the exposed area of the bonding pad of any part of the product with your hands. It is recommended that the tester shall wear insulating gloves when testing the product under live conditions.

12.2、本产品不能在含 Cl₂, H₂S、NH₃、SO_x、NO_x 等腐蚀性气体环境下使用。

12.2、This product cannot be used in the environment containing corrosive gas such as Cl₂, H₂S, NH₃, SO_x, NO_x.

12.3、本产品不能暴露在有大量粉尘、酒精、油等可燃物质环境下使用。

12.3、This product should not be used in the environment exposed to a large amount of dust, alcohol, oil and other flammable substances.

12.4、本产品不适合直接在潮湿的环境下储存、使用。

12.4、This product is not suitable for direct storage and use in a humid environment.

12.5、请勿直接用手或重物压到光源和灯板上其它电子器件。

12.5、Do not directly press the light source and other electronic components on the lamp panel with your hands or heavy objects.