

## High Efficacy LED Series

5050

TS1-E50YL-1001BB

VF 30V / Ra70、Ra80

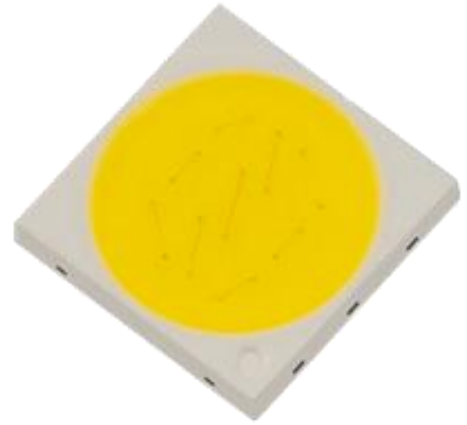

## 特性 Features

- EMC 塑料 EMC Package
- 外观尺寸 Package Dimension: 5.0mm×5.0mm×0.7mm
- 发光角度 Viewing Angle: 120°
- 符合ROHS标准 ROHS Approved

## 描述 Description

同一方5050 产品具有高光效，高显指，低功耗，发光角度广等一系列特性，这些特性使其成为照明应用的首选。  
The TYF 5050 package has high efficacy, high Ra, low power consumption, wide viewing angle and a compact form factor. These features make the package an ideal LED for lighting applications.

## 应用 Applications

- 户外通用照明 Outdoor general lighting
- 工业照明 Industrial lighting
- 线性灯具 Professional downlights
- 替换灯和灯具 Retrofits and fixtures

# 目 录

## Catalogue

|            |  |    |
|------------|--|----|
| 1. 产品编码    | Product Number.....                        | 3  |
| 2. 外形尺寸    | Dimensions.....                            | 3  |
| 3. 极限参数    | Absolute Maximum Ratings.....              | 4  |
| 4. 光电特性    | Electrical-Optical Characteristics.....    | 5  |
| 5. 色区参考图   | The reference map color area.....          | 6  |
| 6. 电压分级    | Voltage Grading.....                       | 7  |
| 7. 典型特性曲线  | Typical Characteristic Curves.....         | 8  |
| 8. 可靠性试验   | Reliability Test Items And Conditions..... | 11 |
| 9. 包装      | Packaging.....                             | 12 |
| 10. 使用注意事项 | Caution.....                               | 14 |

## 1、产品编码 Product Number

|   |   |   |   |   |   |   |   |   |   |   |    |    |    |    |    |   |    |    |    |    |    |
|---|---|---|---|---|---|---|---|---|---|---|----|----|----|----|----|---|----|----|----|----|----|
| 1 | 2 | 3 | - | 4 | 5 | 6 | 7 | 8 | - | 9 | 10 | 11 | 12 | 13 | 14 | - | 15 | 16 | 17 | 18 | 19 |
| T | S | 1 | - | E | 5 | 0 | Y | L | - | 1 | 0  | 0  | 1  | B  | B  | - | C  | 4  | 0  | T  | H  |

| 编码序号 Code No | 含义 PKG Information               |
|--------------|----------------------------------|
| 1-3          | 产品系列 Range of products           |
| 4-8          | 产品外形 Designates product type     |
| 9-12         | 串并方案 Product specifications Size |
| 13-14        | 亮度等级 Class of brightness         |
| 15-19        | 颜色代码 Color code                  |

## 2、外形尺寸 Dimensions

单位(Units):毫米(mm)

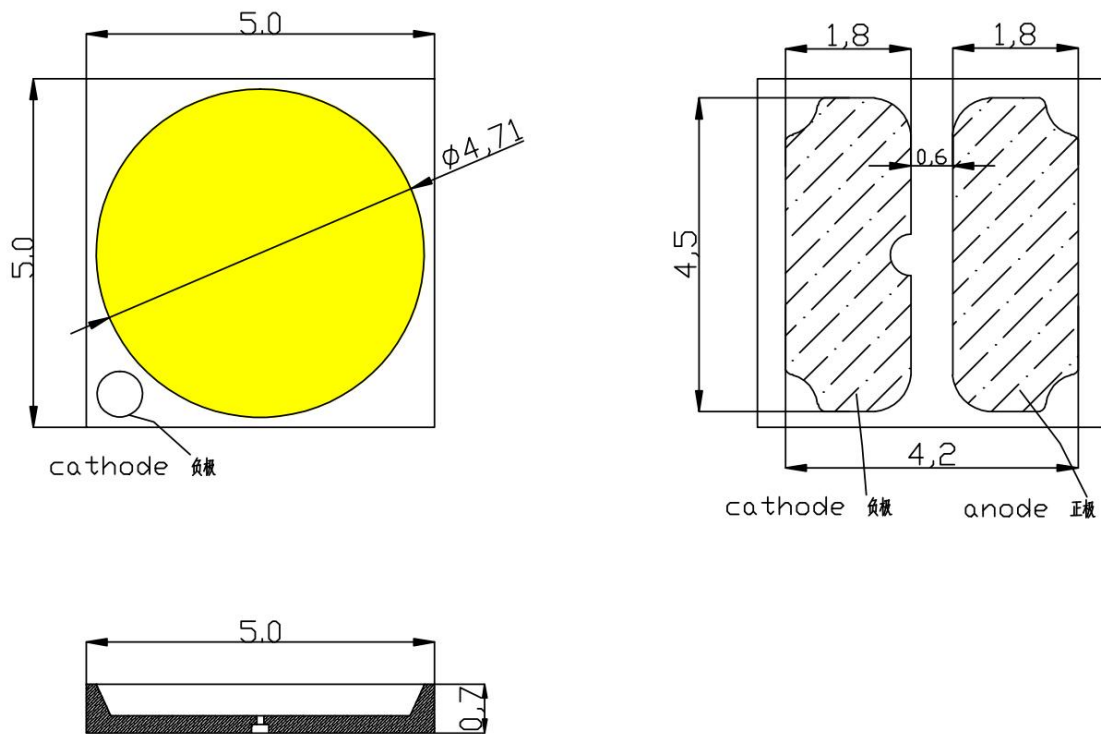

### 备注/Postscript:

所有尺寸单位为 mm，如无特殊说明误差范围为 $\pm 0.2$ mm

All dimensions area in mm tolerance is  $\pm 0.2$ mm unless otherwise noted.

### 3、极限参数 Absolute Maximum Ratings

| 项目<br>Item                               | 符号<br>Symbol | 数值<br>Value                    | 单位<br>Unit |
|--|--------------|--------------------------------|------------|
| 极限功率<br>Limiting power                   | P            | 5.0                            | W          |
| 正向电流<br>Forward Current                  | IF           | ≦160mA                         | mA         |
| 工作温度<br>Operating Temperature            | Topr         | -40°C To +85°C                 | ° C        |
| 结点温度<br>Junction Temperature             | Tj           | 125                            | ° C        |
| 储存温度<br>Storage Temperature              | Tstg         | -40°C To +105°C                | ° C        |
| 静电击穿电压<br>ESD Sensitivity                | ESD          | 2,000V HBM                     | V          |
| 反向电压<br>Reverse Voltage                  | VR           | Reverse testing is not allowed | /          |
| 反向电流<br>Reverse Current                  | IR           | VR=5V 1uA                      | uA         |
| 焊接温度<br>Soldering Temperature            | Tsld         | 260°C/3-5sec.                  | °C/S       |
| 湿度敏感级别<br>Moisture Sensitivity<br>Rating | MSR          | MSL3                           | °C/RH/H    |

#### 补充说明 Additional Remarks

- 本产品建议使用功率为：5W 及以下功率，如要使用 5W-9W 请务必与我司技术部联系，共同协商产品使用条件；  
The recommended power of this product is 5W or below. If you want to use 5W-9W, please be sure to contact the technical department of our company to negotiate the use conditions of the product.
- 极限功率和正向电流 是指模块温度通过使用合适的散热体下的最大设置数值；  
Max power and positive current mean the maximum setting value of the bottom temperature of led light source by using the appropriate heat sink.
- 最初连接错误的反向电压，超出将可能损坏模组；  
Connection error and off-limits voltage may damage LED chip.

4、光电特性 Electrical-Optical characteristics (T<sub>j</sub> = 25°C)表 1: 在 T<sub>j</sub>=25°C时测试的光电参数

| Product<br>产品系列  | CRI<br>显色 | CCT<br>色温(K) | Luminous Flux<br>光通量<br>(lm)160MA | Efficacy<br>光效<br>(lm/W)35MA | Voltage<br>电压 (V)<br>VF160MA | Part Number 产品编码       |
|------------------|-----------|--------------|-----------------------------------|------------------------------|------------------------------|------------------------|
| TS1-E50YL-1001BB | 70        | 2700         | 750-800                           | 205-215                      | 29.0-31.0                    | TS1-E50YL-1001BB-C27TH |
|                  |           | 3000         | 750-800                           | 210-220                      |                              | TS1-E50YL-1001BB-C30TH |
|                  |           | 3500         | 800-850                           | 215-225                      |                              | TS1-E50YL-1001BB-C35TH |
|                  |           | 4000         | 800-850                           | 220-230                      |                              | TS1-E50YL-1001BB-C40TH |
|                  |           | 5000         | 800-850                           | 220-230                      |                              | TS1-E50YL-1001BB-C50TH |
|                  |           | 5700         | 800-850                           | 215-225                      |                              | TS1-E50YL-1001BB-C57TH |
|                  |           | 6000         | 800-850                           | 215-225                      |                              | TS1-E50YL-1001BB-C60TH |
|                  |           | 6500         | 750-800                           | 210-220                      |                              | TS1-E50YL-1001BB-C65TH |
|                  | 80        | 2700         | 700-750                           | 190-200                      | 29.0-31.0                    | TS1-E50YL-1001BB-E27TH |
|                  |           | 3000         | 700-750                           | 195-205                      |                              | TS1-E50YL-1001BB-E30TH |
|                  |           | 3500         | 750-800                           | 200-210                      |                              | TS1-E50YL-1001BB-E35TH |
|                  |           | 4000         | 750-800                           | 205-215                      |                              | TS1-E50YL-1001BB-E40TH |
|                  |           | 5000         | 750-800                           | 205-215                      |                              | TS1-E50YL-1001BB-E50TH |
|                  |           | 5700         | 750-800                           | 200-210                      |                              | TS1-E50YL-1001BB-E57TH |
|                  |           | 6000         | 750-800                           | 200-210                      |                              | TS1-E50YL-1001BB-E60TH |
|                  |           | 6500         | 700-750                           | 195-205                      |                              | TS1-E50YL-1001BB-E65TH |

说明:

**表1备注Table 1 note:**

- 测试环境温度 25 °C, 若使用不同电流或不同的环境温度测试, 会引起色温及电压的变化;  
Testing environment temperature 25 °C, and CCT and voltage will changed if tested in different current and environment temperature.
- 不同标准测试仪正常测试允许公差: 电压±0.1V, 流明±5%, 显指±2, 色坐标±0.005;  
Tolerance among different testing machine: Voltage:±0.1V, Lumen±5%, CRI±2, Color coordinate ±0.005.

## 5、色区参考图 The reference map color area

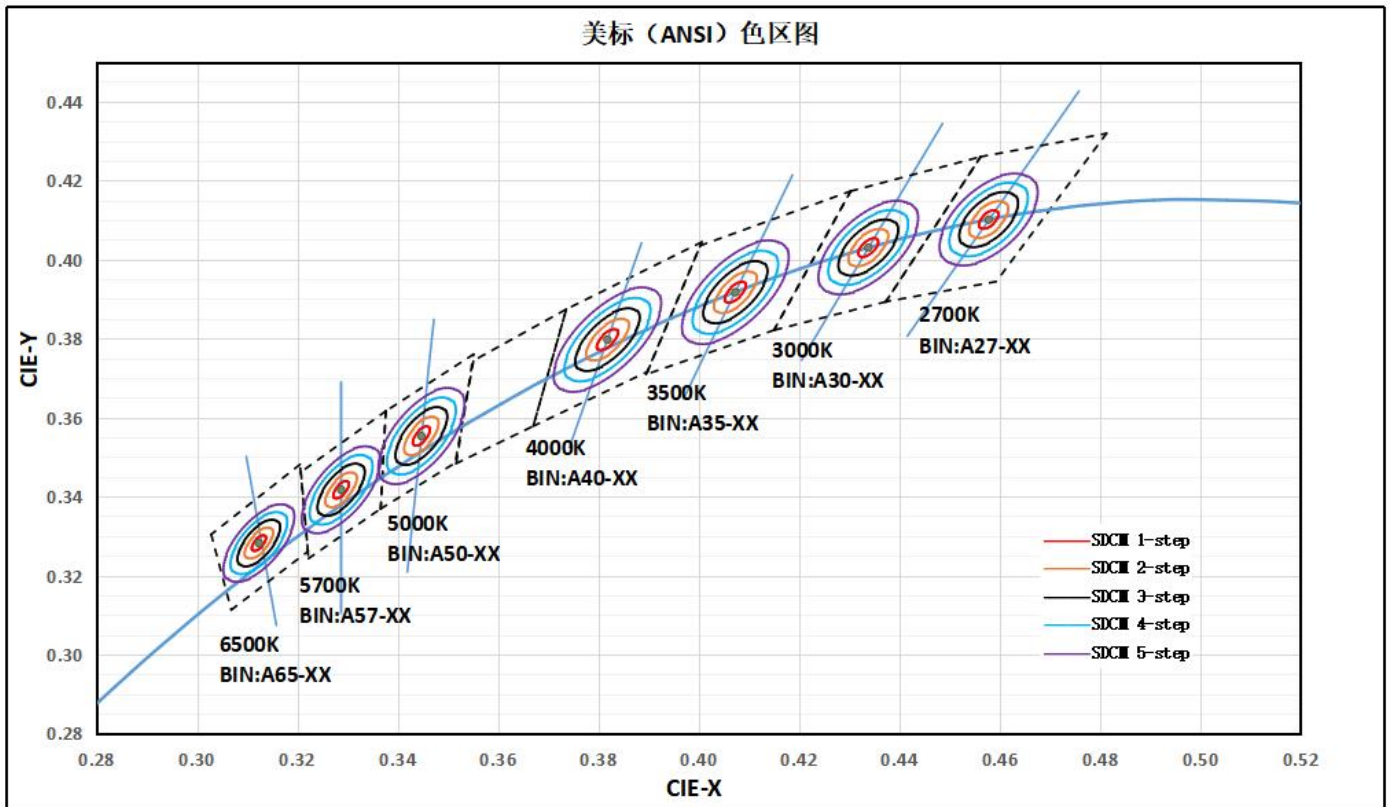

CIE(X, Y)坐标 CIE coordinates (X, Y)

| Nominal<br>CCT | Center Point |        | MAJOR AXIS (a , b) |                    |                    | Ellipse  |
|----------------|--------------|--------|--------------------|--------------------|--------------------|----------|
|                | X            | Y      | 2-Step             | 3-Step             | 5-Step             | Rotation |
| 2700K          | 0.4578       | 0.4101 | (0.00540, 0.00280) | (0.00810, 0.00420) | (0.01350, 0.00700) | 53.70    |
| 3000K          | 0.4339       | 0.4033 | (0.00556, 0.00272) | (0.00834, 0.00408) | (0.01390, 0.00680) | 53.22    |
| 3500K          | 0.4078       | 0.3930 | (0.00618, 0.00276) | (0.00927, 0.00414) | (0.01550, 0.00690) | 54.00    |
| 4000K          | 0.3818       | 0.3797 | (0.00626, 0.00268) | (0.00939, 0.00402) | (0.01570, 0.00670) | 53.72    |
| 5000K          | 0.3446       | 0.3551 | (0.00548, 0.00236) | (0.00822, 0.00354) | (0.01370, 0.00590) | 59.62    |
| 5700K          | 0.3287       | 0.3425 | (0.00497, 0.00213) | (0.00746, 0.00320) | (0.01240, 0.00530) | 59.09    |
| 6500K          | 0.3123       | 0.3283 | (0.00446, 0.00190) | (0.00669, 0.00285) | (0.01120, 0.00480) | 58.57    |

**备注/Postscript:**

色域可控制在色温中心坐标的 5 阶麦克亚当椭圆之内，色温分 bin 参考 ANSI C78.377-2008 .Color area can be controled within 5 SDCm.Bin of color temperature refers to ANSI C78.377-2008.

## 6. 电压分级 Voltage Grading

5050 白光 led 测试正向电压和分类, 正向电压档定义如下:

5050 white led test forward voltage and classification, forward voltage file is defined as follows:

| 产品 Product       | 电压 Min VF (V)@ 160MA | 电压 Max VF (V)@ 160MA |
|------------------|----------------------|----------------------|
| TS1-E50YL-1001BB | 29.0                 | 29.5                 |
|                  | 29.5                 | 30.0                 |
|                  | 30.0                 | 30.5                 |
|                  | 30.5                 | 31.0                 |

### 备注/Postscript:

电压分档标准: 0.5V/档, 光通量分档标准: 50LM/档。光通量允许误差 $\pm 5\%$ 。

Voltage classification standard: 0.5V/ file, luminous flux classification standard: 50LM/ file.

The allowable error of luminous flux is  $\pm 5\%$ .

## 7、典型特性曲线/Typical Characteristic Curves

### (1) 典型光谱分布

Typical spectral distribution

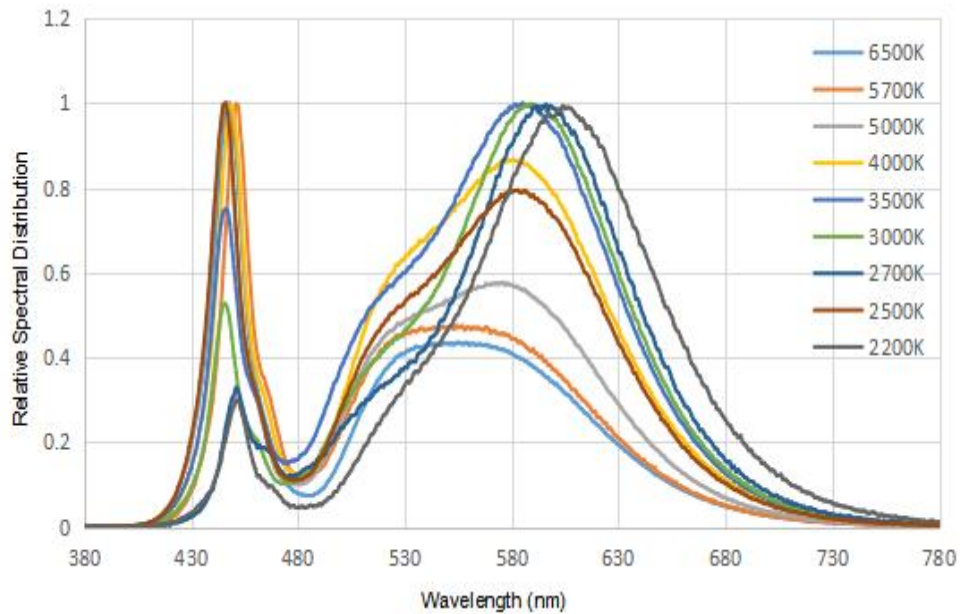

Figure 1a. Typical normalized power vs. wavelength for at test current, RA70  $T_j = 25^\circ \text{C}$ .

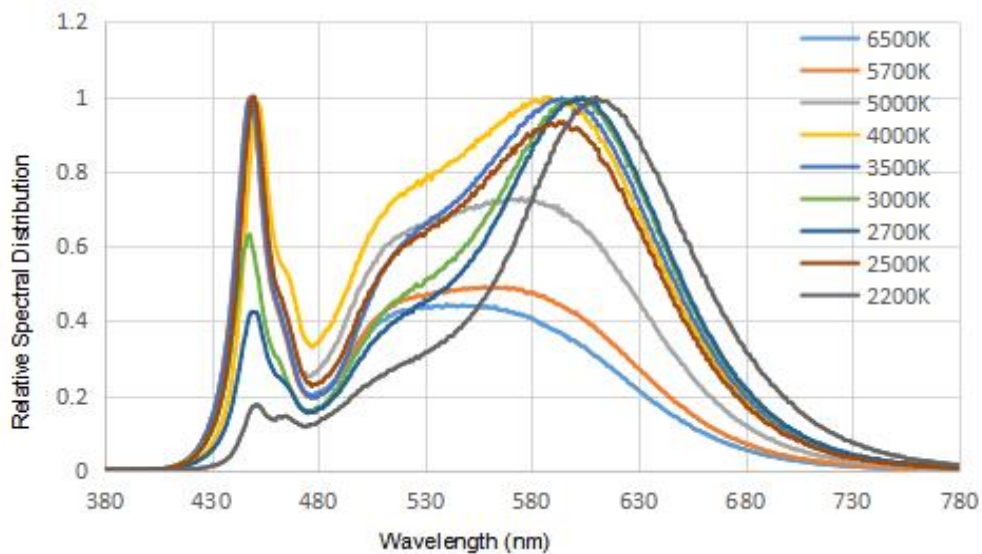
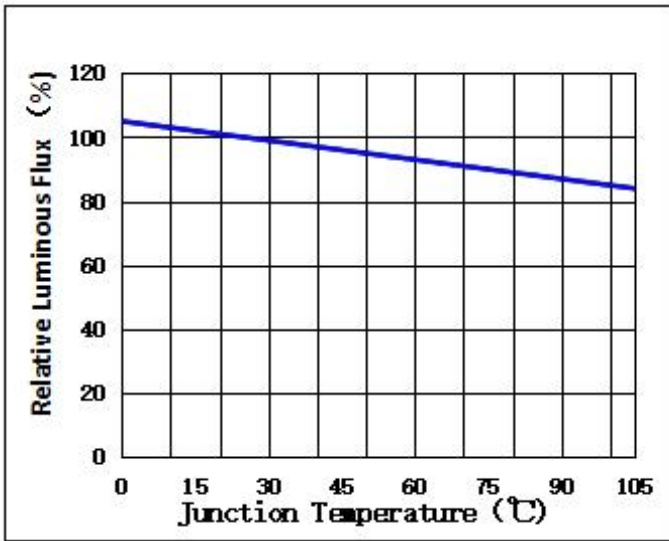

Figure 1a. Typical normalized power vs. wavelength for at test current, RA80  $T_j = 25^\circ \text{C}$ .



# Light Output Characteristics



Relative Luminous Intensity VS Junction Temperature.

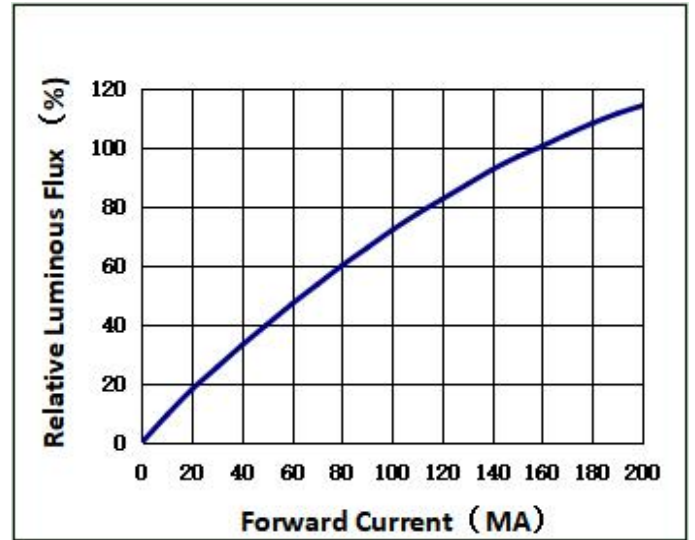

Relative Luminous Intensity VS Forward Current.

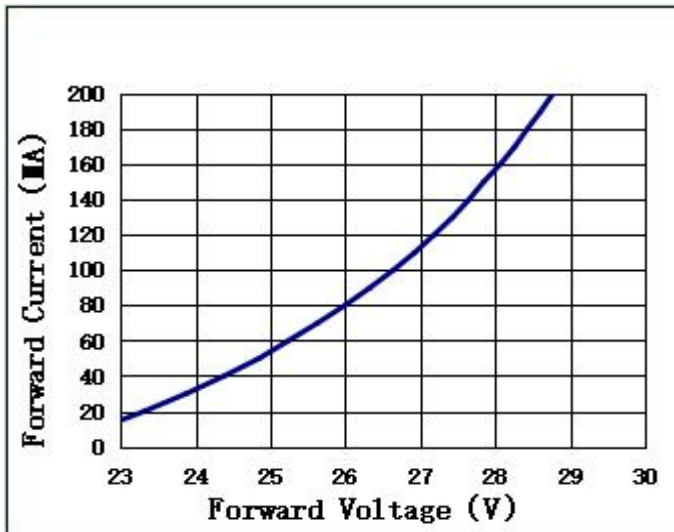

Forward Current VS Forward Voltage.

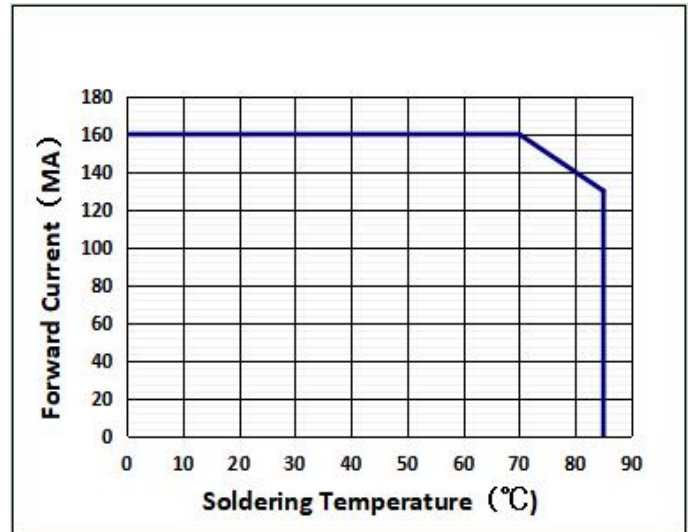

Forward Current VS Soldering Temperature.

## Radiation Pattern Characteristics

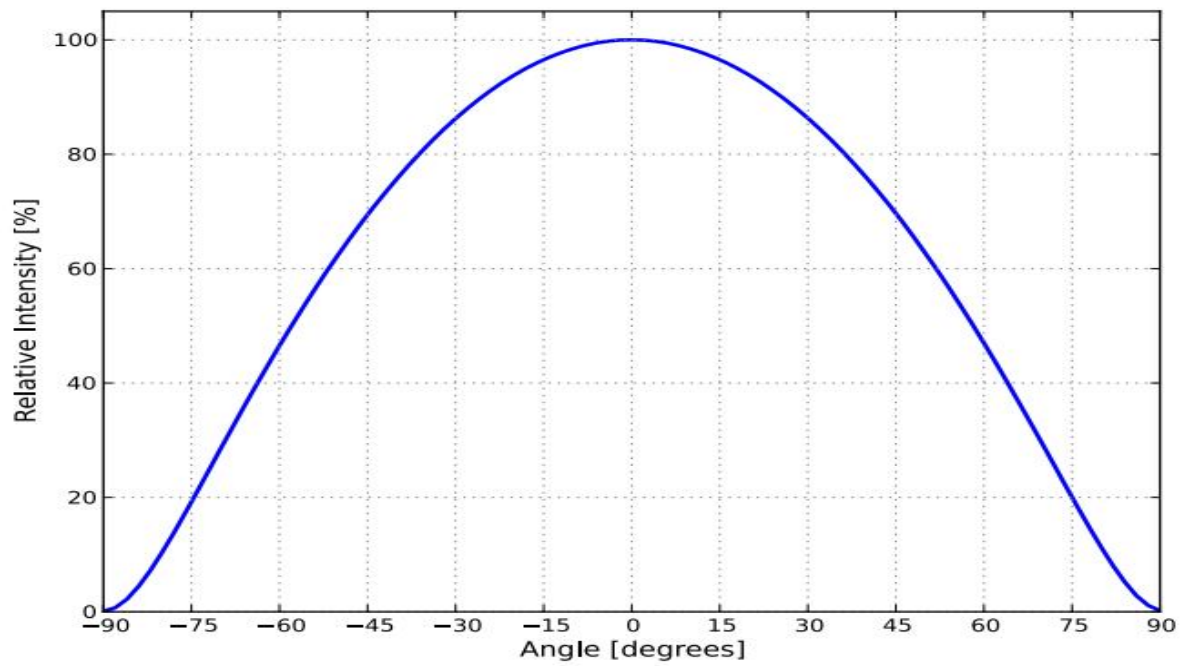

Typical radiation pattern for T at test current,  $T_j = 25^\circ \text{C}$ .

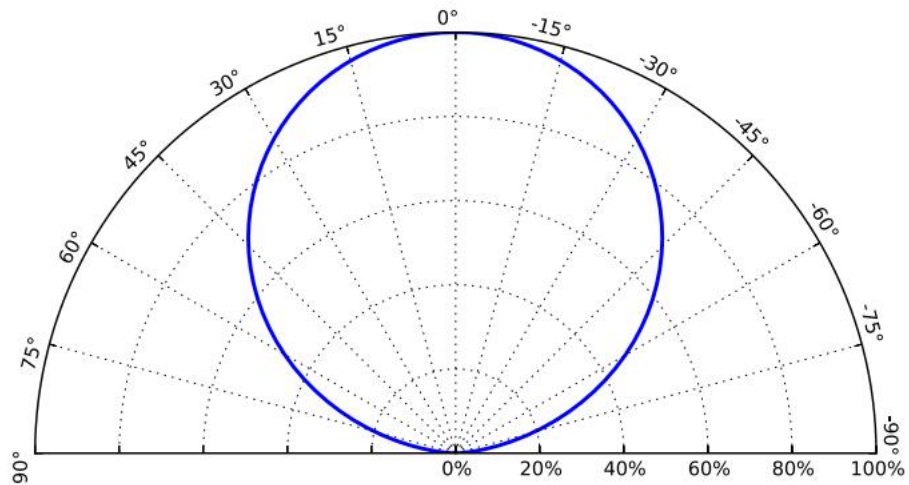

Typical polar radiation pattern forat test current,  $T_j = 25^\circ \text{C}$ .

## 8、可靠性试验/Reliability Test Items And Conditions

测试项目和测试条件 Testing items and testing conditions



| 序号<br>No. | 试验项目<br>Test Item  | 参考标准<br>reference standard | 试验条件<br>Test condition   |                   | 样品数量<br>Sample<br>Quantity | 失效数量<br>Failure<br>Quantity |
|-----------|--|----------------------------|--|-------------------|----------------------------|-----------------------------|
| 1         | 高低温冲击<br>Thermal shock                                   | JESD22-A104E               | (-40°C<br>15min)-----+120°C<br>(15min),<br>↑ ↓ 10 mins, 200cycles      |                   | 22pcs                      | 0                           |
| 2         | 高温存放<br>High Temperature<br>Storage                      | JESD22-A103D               | +100°C, 1000h  |                   | 22pcs                      | 0                           |
| 3         | 低温存放<br>Low Temperature<br>Storage                       | JESD22-A119                | -40°C, 1000h   |                   | 22pcs                      | 0                           |
| 4         | 高温高湿老化<br>High Temperature, High<br>Humidity, Aging Test | JESD22-A101C               | T=+85°C, R<br>H=85%  | IF=160MA<br>1000h | 22pcs                      | 0                           |
| 5         | 高温使用寿命<br>High-temperature<br>operation                  | IES LM80-2015              | T=+105°C,  | IF=160MA<br>1000h | 22pcs                      | 0                           |
| 6         | 低温使用寿命<br>Low temperature<br>operation                   | JESD22-A108D               | T=-40°C,   | IF=160MA<br>1000h | 22pcs                      | 0                           |
| 7         | 回流焊湿度敏感实验<br>Moisture/Reflow<br>Sensitivity Test         | J-STD-020E                 | Precondition:<br>60°C. 60%RH. 168H<br>Tslid=260°C. 10sec. 3<br>Reflows |                   | 22pcs                      | 0                           |

失效判定标准 Criteria For Judging Damage

| 项目<br>Test Items        | 测试条件<br>Test Condition | 判定标准<br>Criteria For Judgement |              |
|-------------------------|------------------------|--------------------------------|--------------|
|                         |                        | Min. 最小                        | Max. 最大      |
| 正向电压<br>Forward Voltage | IF=160MA               | /                              | U. S. L*1. 1 |
| 反向电流<br>Reverse Current | VR=5V                  | /                              | U. S. L*2. 0 |
| 光通量<br>Luminous Flux    | IF=160MA               | L. S. L*0. 7                   | /            |

### 9、包装/Packaging

铝箔袋标签 Aluminum foil bag label

|   |              |   |
|---|--------------|---|
| <b>TYF LED</b>  |              | Natural Light for Healthy Life  |
| TYPE: TS1-E50YL   |              |   |
| P/N: TS1-E50YL-1001BB-C40TH   |              | 01  |
|  |              |  |
| L/N : C2211017  | QTY: 2000Pcs |   |
|  |              |   |
| XY: 40TH  | Bin: 5SDCM   | Code: 01  |
| SPEC: 5.0W\23.5-24.0V\45-160mA\RA70\4000K\220-230Lm/w                             |              |   |

卷盘尺寸/Reel Dimensions (单位:毫米 Units:mm)

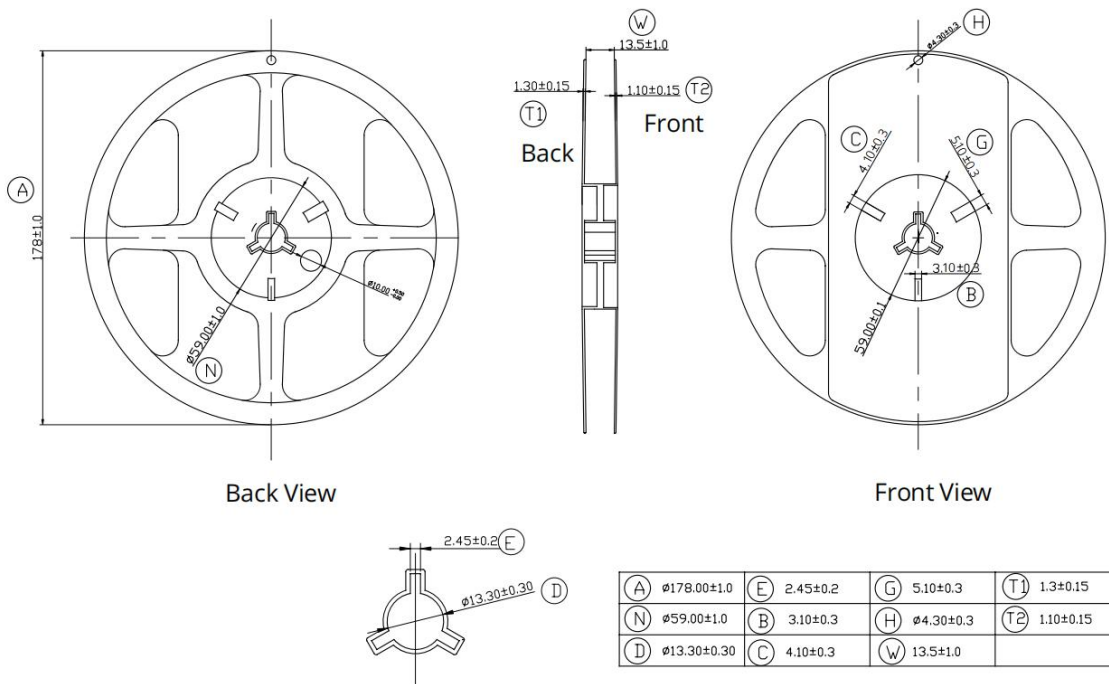

装带规格 Taping Specifications (单位:毫米 Units:mm)

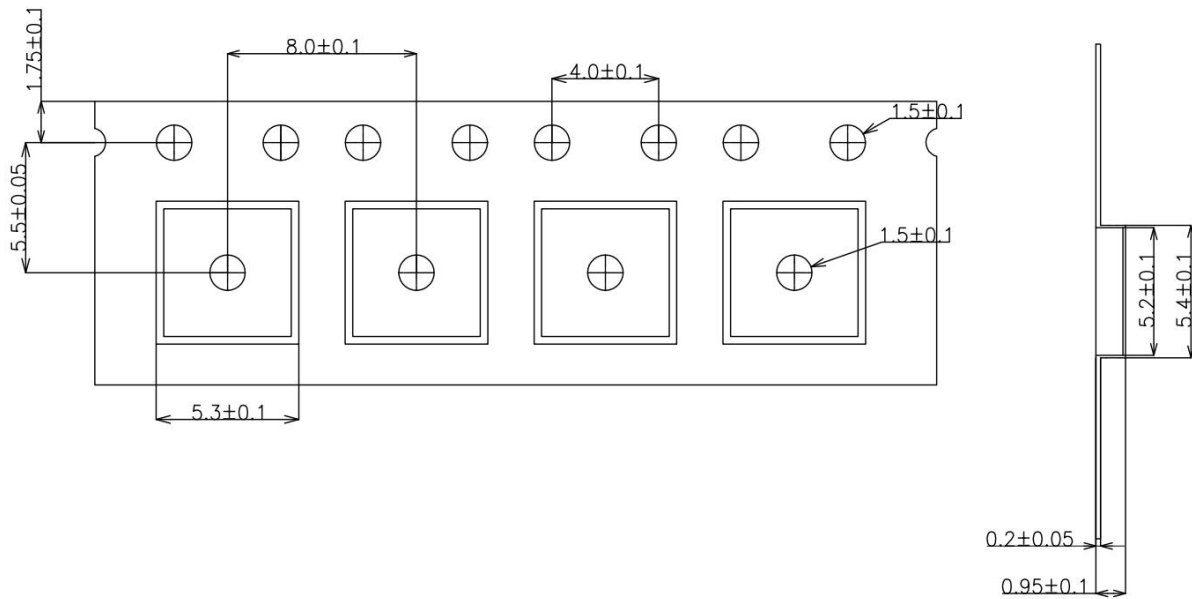

### Moisture proof packing 防潮包装

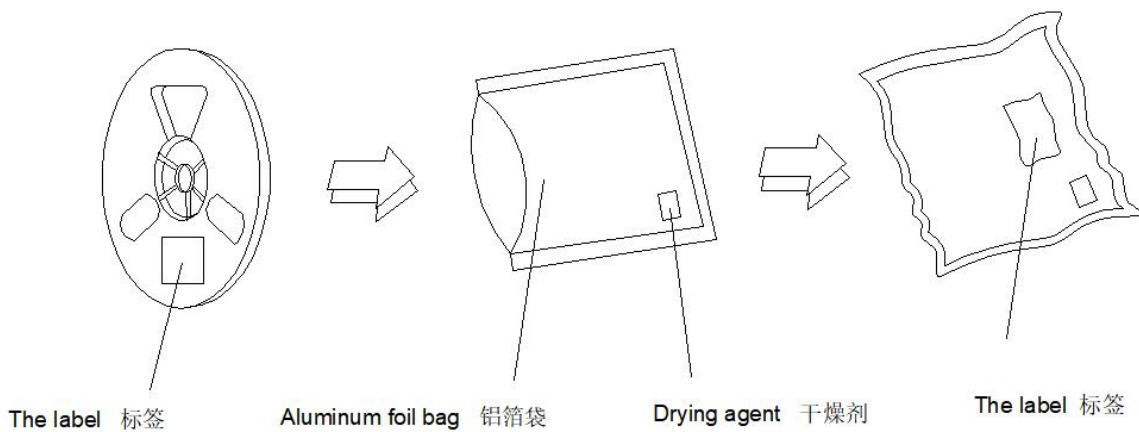

每卷数量 2000 个/卷. Package: 2000Pcs/Reel

#### 备注 Postscript:

- LED 编带后放置在铝箔袋中真空包装，内置湿度卡，在装带之后纸箱包装；  
After the LED is braided, it is placed in a vacuum package in an aluminum foil bag, with a built-in humidity card. The LED is packed in a carton after being braided.
- 最小包装标签注明以下: 产品名称、批号、参数范围、数量；  
The label on the minimum packing unit shows ; Part Number, Lot Number, Ranking, Quantity.
- 请注意防水防潮；  
Keep away from water, moisture in order to protect the LEDs.
- 须采取适当防护措施, 以防包装箱跌落或受到强力撞击造成对产品的损伤；  
The LEDs may be damaged if the boxes are dropped or receive a strong impact against them. So precautions must be taken to prevent any damage.

## 10、使用注意事项 Caution

### 1. 储藏条件 Storage conditions

打开前:温度为 5~30℃, 相对湿度低于 60%。(打开后模组应在 24H 之内使用完毕), 如未用完之产品, 请进行除湿并抽真空后密封保存。湿度卡变色或包装袋漏气等现象必须除湿, 除湿条件: 60° C±5° C, 24H。产品密封保存有效使用期为 3 个月;

Before open: temperature is 5 ~ 30 °C, relative humidity below 60%. ( the module should be used within 24H when opens), if not, please dehumidification and vacuum sealing .Humidity card changes color or bags leak must dehumidifier, dehumidifier conditions: 60° C±5° C, 24 h. The effective use period of product seal is 3 months.

### 2. 取放条件 Attention

取放及组装过程禁止挤压发光区胶体表面, 注意 SMT 贴装吸嘴选择, 防止压死灯现象;

During use and assembly, please do not press light-emitting colloid surface, pay attention to the choice of suction nozzle SMT , to prevent chip die.

### 3. 静电防护 Electrostatic protection

LED 属于 I 级静电敏感器件, 接触、使用过程做好防静电保护;

LED belong to grade I electrostatic sensitive device, please do ESD protection when touch and Use;

### 4. 清洁条件 Clean condition

LED 胶体表面脏污, 可用酒精清洗, 不可用丙酮等腐蚀性的清洗溶剂清洗;

If LED colloid surface dirt, use alcohol to clean. Can't use acetone or corrosive to clean.

### 5. 灯珠检测 The electrical test

单颗灯珠电 30V 的设置不能高于 35V, , 灯珠有正负方向, 焊反则不能正常点亮;

The setting of a single lamp bead electricity of 30V can not be higher than 35V, the lamp bead has positive and negative direction, welding can not be lit normally;



## 6.焊接条件 Welding conditions

可用加热台或回流焊机焊接。加热台焊接： $\leq 260^{\circ}\text{C}$ ，熔锡后 3-6 秒内取出，最多可焊接 2 次，自然降温到室温，方可包装。回流焊接如图：

Heating units or reflow welding machine are available to weld. Heat welding machine:  $260^{\circ}\text{C}$  or less and molten tin, 3-6 seconds after maximum welding 2 times, natural cooling to room temperature, before packing. Reflow soldering is shown in figure:

|          |   |
|----------|---|
| 预热温度     | 无铅<br><b>180-200<math>^{\circ}\text{C}</math></b> |
| 预热时间     | <b>&lt;120S 秒</b>                                 |
| 峰值温度     | <b>&lt;260<math>^{\circ}\text{C}</math></b>       |
| 峰值温度焊接时间 | <b>&lt;10 秒</b>                                   |

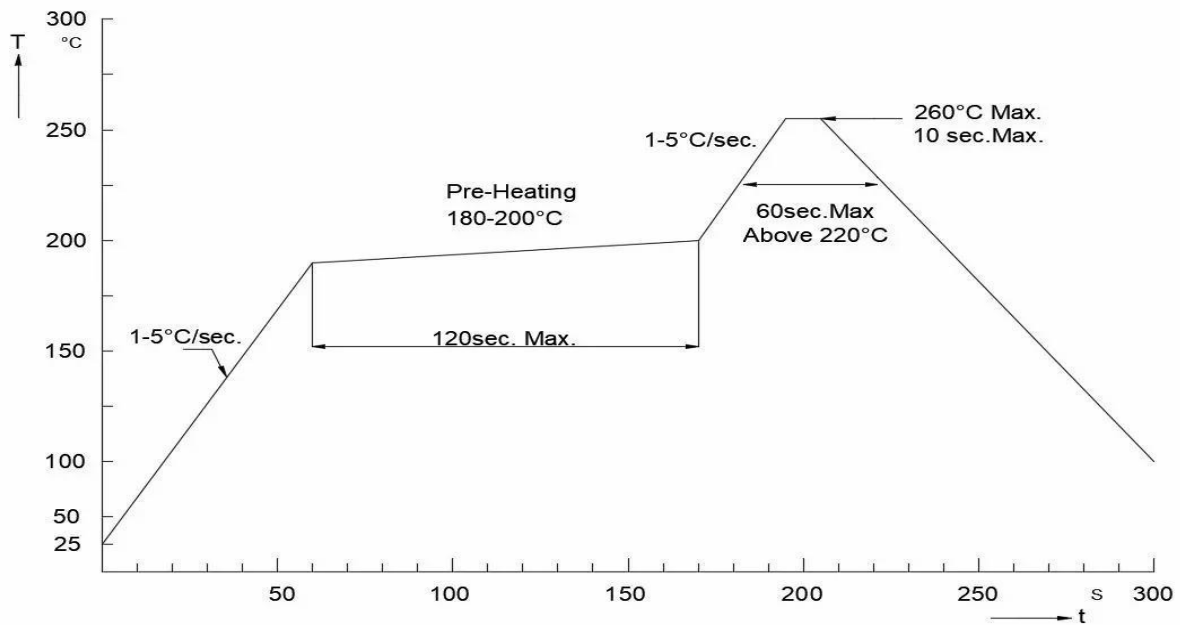

说明：最多只可回焊两次，且在首次回焊后须冷却至室温之后方可进行第二次回焊。

LEDs can be welded twice at most, it can be welded again only after the LEDs are cooled as room temperature.

## 7. 电路及散热设计 Design of circuit and heat dissipation

7.1 产品正常工作温度：TS 点（负极焊盘）小于 85℃，如果超出我司给定要求，客户必须做产品可靠性评估，风险由客户承担；

Normal operating temperature: TS point (negative pad) is less than 85 °C, if exceeded, customer needs to make reliability assessment, customer takes the risk.

7.2 电源驱动选取：本产品需使用恒流源进行驱动，且输出电流符合规格书上的功率使用范围，如需使用恒压源或其他使用条件，请进行使用效果风险评估；

Power Supply Select: This product is powered by using a constant current driver, and the output current of the power range meets the requirement of specifications book, if use constant voltage source or other conditions, please do risk assessment.

## 8. 使用环境要求 Environmental requirements

此产品设计不针对下列任何条件，如在下列任何条件下使用产品，请确定其正常性能和可靠性；

如：潮湿，有露水凝霜，盐水空气，腐蚀性气体的地方（CL, H<sub>2</sub>S, NH<sub>3</sub>, SO<sub>2</sub>, NO<sub>x</sub>, 等）；太阳直晒下，户外暴露，多灰尘的地方。水中，油，医用液体和有机溶剂等；

This product can not use under below situations, if use the product in any of the below conditions, please make sure the performance and reliability; Such as: wet, frost, salt air, corrosive gases (Cl, H<sub>2</sub>S, where NH<sub>3</sub>, SO<sub>2</sub>, NO<sub>x</sub>); Exposure under the sun, exposure outdoor, dusty. Water, oil, liquid medical and organic solvent.

## 9. 使用兼容性 Using Compatibility

9.1 灯具中气体的化学成分以及光源周围的环境对灯具的寿命至关重要，特别是当您选择在灯具设计中使用化学成分时尤为重要。考虑使用任何材料之前，务必先咨询产品供应商或 LED 制造商。使用某种材料前获取的信息越多，灯具寿命期内的性能越高；

The chemical composition of gas in lamps and surrounding environment of light source are essential to the life of the lamps, especially when you choose to use chemical composition, it is particularly important in lighting design. Before considering the use of any material, be sure to consult the product supplier or LED manufacturer. The more information obtained before using some material, the higher the performance of the lamp.

9.2 产品色差问题 Color difference matters needing attention

不同 BIN 的 LED 光电参数有差异，使用前，须仔细评估；

The different Bin led has different photoelectric data, before use, please assess carefully.

9.3 具体使用注意事项参考《SMD 产品使用注意事项》；

Specific please check the <<Precautions for using SMD products>> for reference